

PRODUCT GUIDE



04

STANHAY HISTORY

A brief overview of our company history

06

PRODUCT RANGE

Our full product range and data comparison table

10

BELT DRILLS

Our economical belt drill range

16

AIR DRILLS

Our industry leading air drill range

26

CELL WHEEL DRILLS

Our robust cell wheel range

32

TOOLBARS AND EXTRAS

Our range of toolbars and extras

34

BESPOKE MACHINES

Our ability to produce bespoke machines to your specification

36

DEALER MAP

Find a dealer close to you

38

CONTACT

Our contact details

● Welcome to our product guide where you will find information on our entire precision seed drill range. Our experience with precision seed drills spans over 60 years and our range of products is trusted by thousands of vegetable, salad crop and other small seed growers worldwide. For more information please get in touch with us or your local dealer.

Formed by two successful British manufacturers who can trace their history back over 125 years.



• 1960s

Stanhay and Webb develop belt and cell wheel precision seeding technologies.

• 1970s

Stanhay and Webb merge to form Stanhay Webb Ltd and become the world's leading specialists in the design and manufacture of precision seed drills.

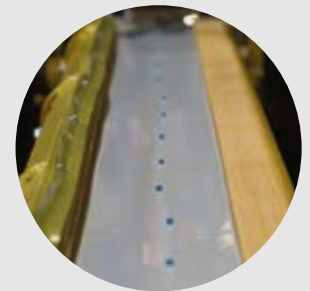

• 1980s

Series of major developments in precision drilling technology and the development of the patented multiline Singulaire vacuum metering unit. Stanhay wins a series of major awards including the Royal Agricultural Society's Burke Trophy and a Queens Award for Technological Achievement in 1995.



• 2000s

Stanhay Webb Ltd moves to Grantham, Lincolnshire where Salvo and Dart drills are developed for large seed and precision cereal drilling.

• 2010s

Purchases a new factory in Bourne, Lincolnshire with sister companies Boss Cabins and Heimdall (UK) Ltd and invests in manufacturing facilities.

• 1990s

Successful export market is built up in more than 60 countries and inter-row hoes and fertiliser applicators are added to the product range.

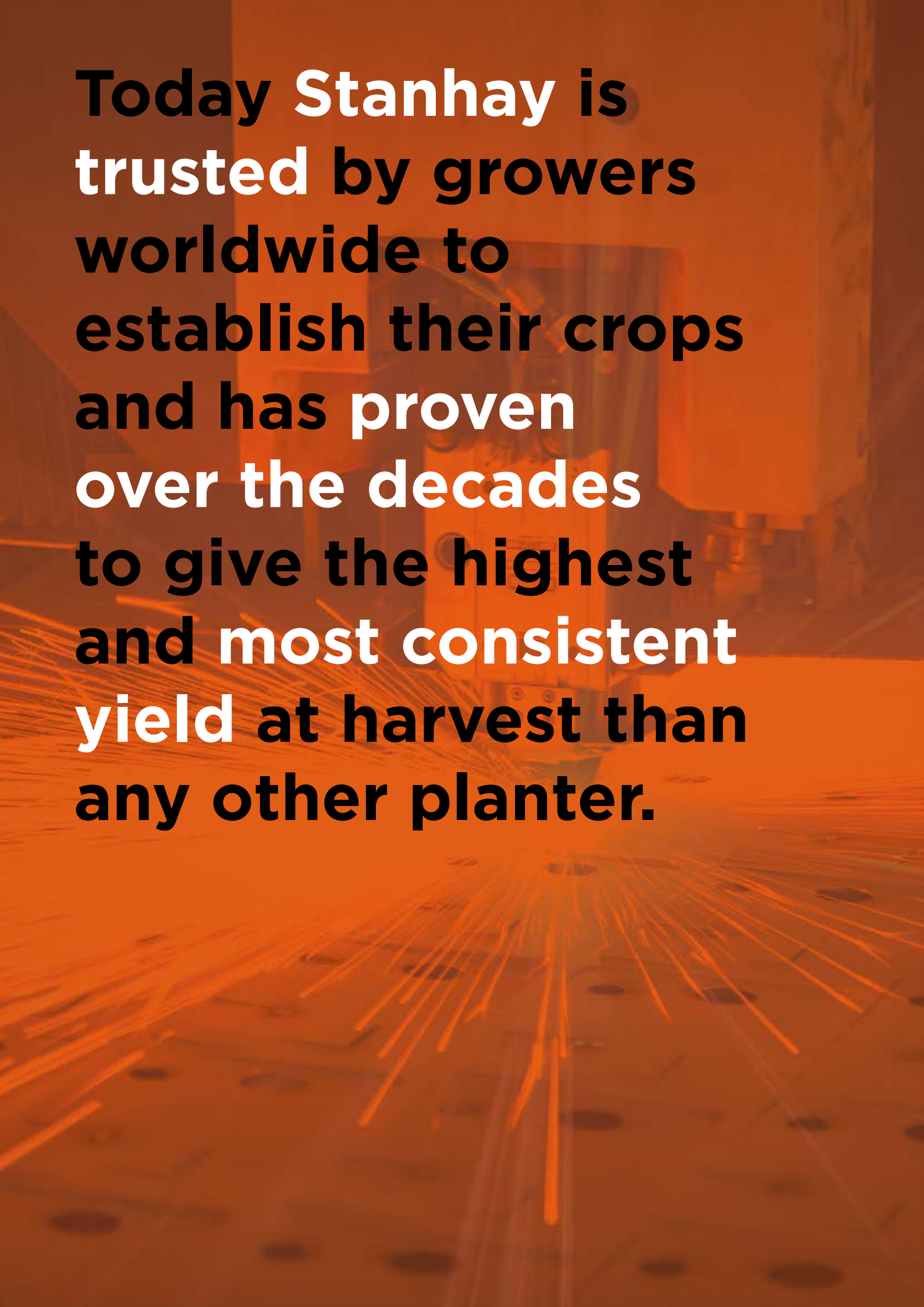

**Today Stanhay is
trusted by growers
worldwide to
establish their crops
and has proven
over the decades
to give the highest
and most consistent
yield at harvest than
any other planter.**

Our Bourne headquarters is home to all our departments including administration, sales, service, assembly, design and testing. Our engineers use the latest 3D computer aided design software and our on-site manufacturing facilities include computer numerical control (CNC) laser cutters, CNC press brakes, robot and manual welding and paint. Meaning that in conjunction with Stanhay's growing network of international distributors and dealers the right drill, part or technical support is always available when needed.

Often copied but never bettered, the core Stanhay technology differs from other products by allowing the grower to plant up to 4 lines of produce from one single row unit using pelleted, coated or natural seed. Couple this with low seed drop, innovative linkage designs to maintain constant seed depth and a range of accessories to suit a huge range of ground conditions and you have the recipe for unsurpassed precision seed placement and the very best start for your crop.

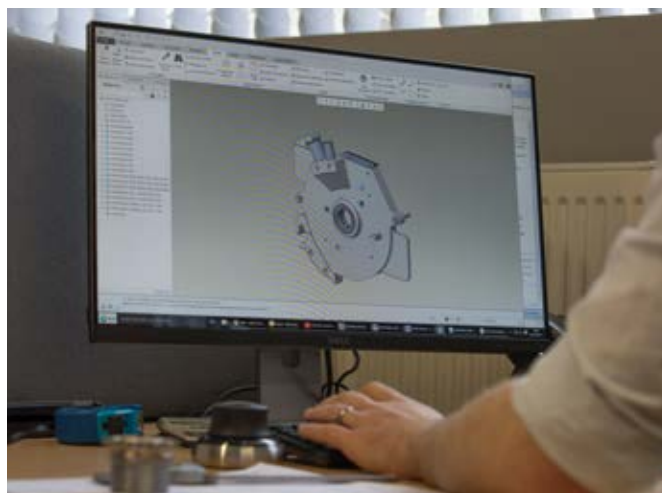

Data Comparison Table

	BELT DRILLS			CELL WHEELS	
	820 HANDPUSH	840	870	SEVEN	NINE
PLANTER TYPE	BELT	BELT	BELT	CELL WHEEL	CELL WHEEL
SEED TYPE	NATURAL + PELLETED	NATURAL + PELLETED	NATURAL + PELLETED	REGULAR SHAPED OR PELLETED	REGULAR SHAPED OR PELLETED
MULTILINE CAPABILITY	1-3 LINE	1-3 LINE	1-3 LINE	SINGLE LINE	SINGLE LINE
HOPPER CAPACITY (LITRES)	4	4 / 8	4 / 8	12	12
TOOLBAR	NONE	60MM DIAMOND	60MM DIAMOND	100MM OR 180MM SQUARE	100MM OR 180MM SQUARE
MINIMUM SEED SPACING	10MM	10MM	10MM	30MM	30MM
MIN/MAX SEED SIZE	1MM/15MM	1MM/15MM	1MM/15MM	1MM/10MM	1MM/10MM
MIN/MAX NUMBER OF ROWS PER MACHINE	1	1-5	2-18+	2-18+	2-18+
MINIMUM ROW SPACING	N/A	200MM	200MM	250MM	250MM
MINIMUM LINE SPACING	25MM	25MM	25MM	N/A	N/A
APPROX ROW UNIT WEIGHT (KG)	43	34	35	58	60
ROW UNIT LENGTH (MM)	1130 (excluding handles)	1130	1100	1400	1400
DEPTH CONTROL	INCREMENTAL 5MM STEPS	INCREMENTAL 5MM STEPS	INCREMENTAL 5MM STEPS	INCREMENTAL 2.5MM STEPS	INCREMENTAL 2.5MM STEPS
COVERER OPTIONS	DRAG	DRAG	DRAG	ARM	ARM
WHEEL OPTIONS	STAINLESS / CAGE	STAINLESS / CAGE	STAINLESS / CAGE	STAINLESS / CAGE / RUBBER	STAINLESS / CAGE / RUBBER
SEED PRESS WHEELS AVAILABLE	NO	NO	NO	YES	YES
ROW UNIT DOWN FORCE ADJUSTMENT	NO	NO	NO	YES	YES
REAR WHEEL DOWN FORCE ADJUSTMENT	NO	YES	YES	YES	YES
DRIVE SYSTEM	UNIT REAR WHEEL	UNIT REAR WHEEL	7 SPEED PULLEY DRIVE	12 SPEED CHAIN DRIVE	ELECTRIC MOTOR
TRACTOR REQUIREMENT	NONE - PEDESTRIAN OPERATED OR LIVE STOCK TOWED	COMPACT TRACTOR / TRACTOR	COMPACT TRACTOR / TRACTOR	SMALL OR LARGE TRACTOR	SMALL OR LARGE TRACTOR
LINKAGE CATEGORY	NONE	CAT 1	CAT 1/2	CAT 2	CAT 2

Please use the table below to help find the right product for you.

AIR DRILLS

780	780HD	785	STAR	STAR PLUS	PROAIR
AIR	AIR	AIR	AIR	AIR	AIR
NATURAL + PELLETED	NATURAL + PELLETED	NATURAL + PELLETED	NATURAL + PELLETED	NATURAL + PELLETED	NATURAL + PELLETED
1-4 LINE	1-4 LINE	1-4 LINE	1-4 LINE	1-4 LINE	1-4 LINE
1 / 2	1 / 2	1 / 2 / 4	1 / 2 / 4	1 / 2 / 4	1 / 2 / 4
60MM DIAMOND	60MM DIAMOND	60MM DIAMOND	100MM OR 180MM SQUARE	100MM OR 180MM SQUARE	100MM OR 180MM SQUARE
7MM	7MM	7MM	7MM	7MM	7MM
1MM/10MM	1MM/10MM	1MM/10MM	1MM/10MM	1MM/10MM	1MM/10MM
2-18+	2-18+	2-18+	2-18+	2-18+	2-18+
200MM	150MM	200MM	250MM	250MM	210MM OR 150MM
21.6MM	21.6MM	21.6MM	21.6MM	21.6MM	21.6MM
48	46	50	58	70	40
1340	1340	1340	1400	1750	1244
INCREMENTAL 2.5MM STEPS	INCREMENTAL 2.5MM STEPS	INCREMENTAL 5mm STEPS	INCREMENTAL 2.5MM STEPS	INFINITE CONTROL	INFINITE CONTROL
DRAG OR ARM	DRAG OR ARM	DRAG OR ARM	DRAG OR ARM	DRAG OR ARM	DRAG OR ARM
STAINLESS / CAGE / RUBBER	STAINLESS / CAGE / RUBBER	STAINLESS / CAGE / RUBBER	STAINLESS / CAGE / RUBBER	STAINLESS / CAGE / RUBBER	STAINLESS / CAGE / RUBBER
YES	YES	YES	YES	YES	YES
NO	NO	NO	YES	YES	YES
NO	NO	YES	YES	NO	YES
28 SPEED CHAIN DRIVE	28 SPEED CHAIN DRIVE	28 SPEED CHAIN DRIVE	28 SPEED CHAIN DRIVE	28 SPEED CHAIN DRIVE	28 SPEED CHAIN DRIVE
SMALL OR LARGE TRACTOR WITH PTO/HYDRAULICS	SMALL OR LARGE TRACTOR WITH PTO/HYDRAULICS	SMALL OR LARGE TRACTOR WITH PTO/HYDRAULICS	SMALL OR LARGE TRACTOR WITH PTO/HYDRAULICS	SMALL OR LARGE TRACTOR WITH PTO/HYDRAULICS	SMALL OR LARGE TRACTOR WITH PTO/HYDRAULICS
CAT 1/2	CAT 2	CAT 2	CAT 2	CAT 2	CAT 2

Belt drills

Stanhay's belt metering units are lightweight, simple and extremely versatile and can be used with a wide range of both raw and coated seeds. From a pedestrian operated unit to large tractor mounted machines our drills can suit both the small and large grower.

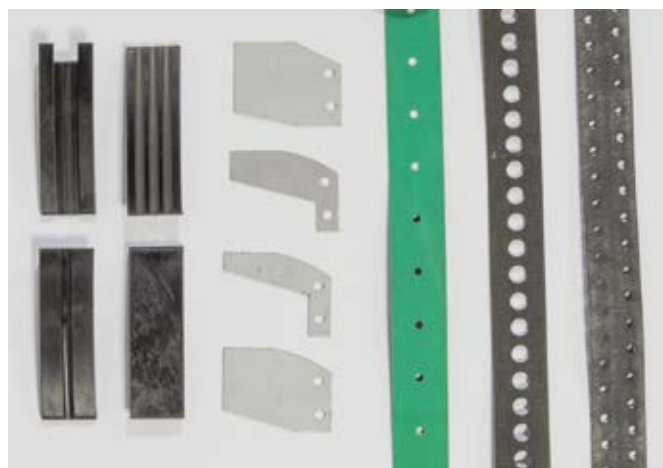

Just some of the seeds you can handle are listed below:

The metering unit accurately places seed in the ground with the minimum of damage as every moving part is rubber covered. Seeds in the hopper fall past the choke (A) which regulates the quantity of seed in the chamber. The seed belt (B) is rotated clockwise by the drive wheel (C) while the repeller wheel (D) rotates anticlockwise to remove excess seed away from the holes in the belt only allowing the required amount to drop through at the end of the spring base (E). The seed drop into the bottom of the furrow is only 25mm minimising bounce or roll of the seeds.

By fitting the right combination of coulter, choke, base and seed belt punched with the correct size and number of holes in single, double or triple lines you can plant a wide variety of seed types at any spacing or pattern. Swapping these items to switch between seed types can all be done without the need for tools.

The metering unit can be fitted into three different chassis types to suit a range of grower requirements.

- | | |
|-------------|------------|
| Asparagus | Mustard |
| Beans | Onions |
| Broccoli | Parsley |
| Brussels | Parsnip |
| Cabbage | Peas |
| Carrot | Pepper |
| Cauliflower | Radish |
| Chicory | Red Beet |
| Coriander | Spinach |
| Cucumber | Sugar Beet |
| Fodder Bee | Swede |
| Kale | Sweet Corn |
| Leek | Tomato |
| Lettuce | Turnip |

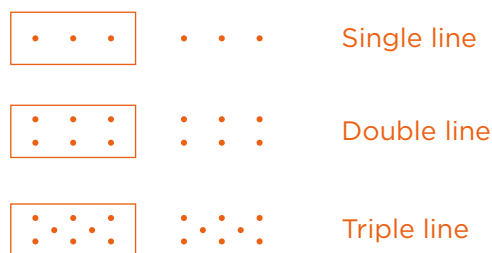

820 HANDPUSH

The highly versatile 820 Handpush is designed for planting small areas and quantities of seed at a time. The large diameter rear cage wheel and ergonomic handles makes it easy to push. The four speed pulley drive gives four seed spacings per seed belt.



Key Features

- 1 4 speed pulley drive
- 2 5mm depth adjustment increments via coulter stem between 0-50mm
- 3 Driven by large diameter rear cage wheel
- 4 Handpush or live stock towed
- 5 Adjustable height handlebars
- 6 4 litre seed hopper
- 7 Marker Arm



840

The 840 is designed to fit behind compact and small tractors or ATVs. An ideal machine for the smaller grower or market gardener drive comes from the large diameter rear cage wheel. The four speed pulley drive gives four seed spacings per seed belt.

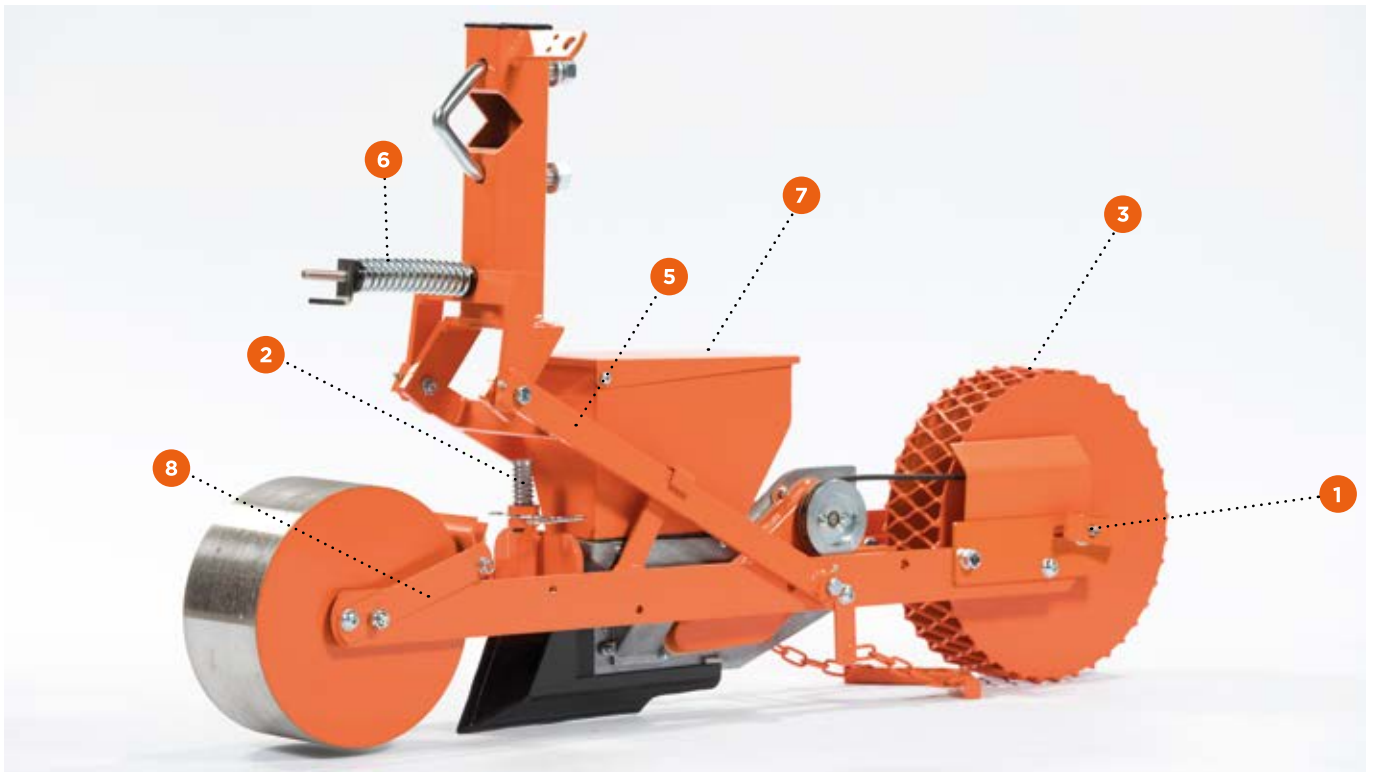

Key Features

- 1 4 speed pulley drive
- 2 5mm depth adjustment increments via coulters between 0-50mm
- 3 Driven by large diameter rear cage wheel
- 4 Lightweight design for use with smallest tractors or ATVs
- 5 Floating linkage
- 6 Adjustable rear wheel pressure via spring
- 7 4 litre seed hopper
- 8 Wheel scrapers

870

Used all over the world the 870 is the market leading belt planter. With a 7 speed pulley drive courtesy of adjustable height landwheels, the 870 can work on the flat or bed setups. Available from 2 rows up to 18 rows and capable of multiline planting, the 870 is robust, scalable and adaptable for every seed type.

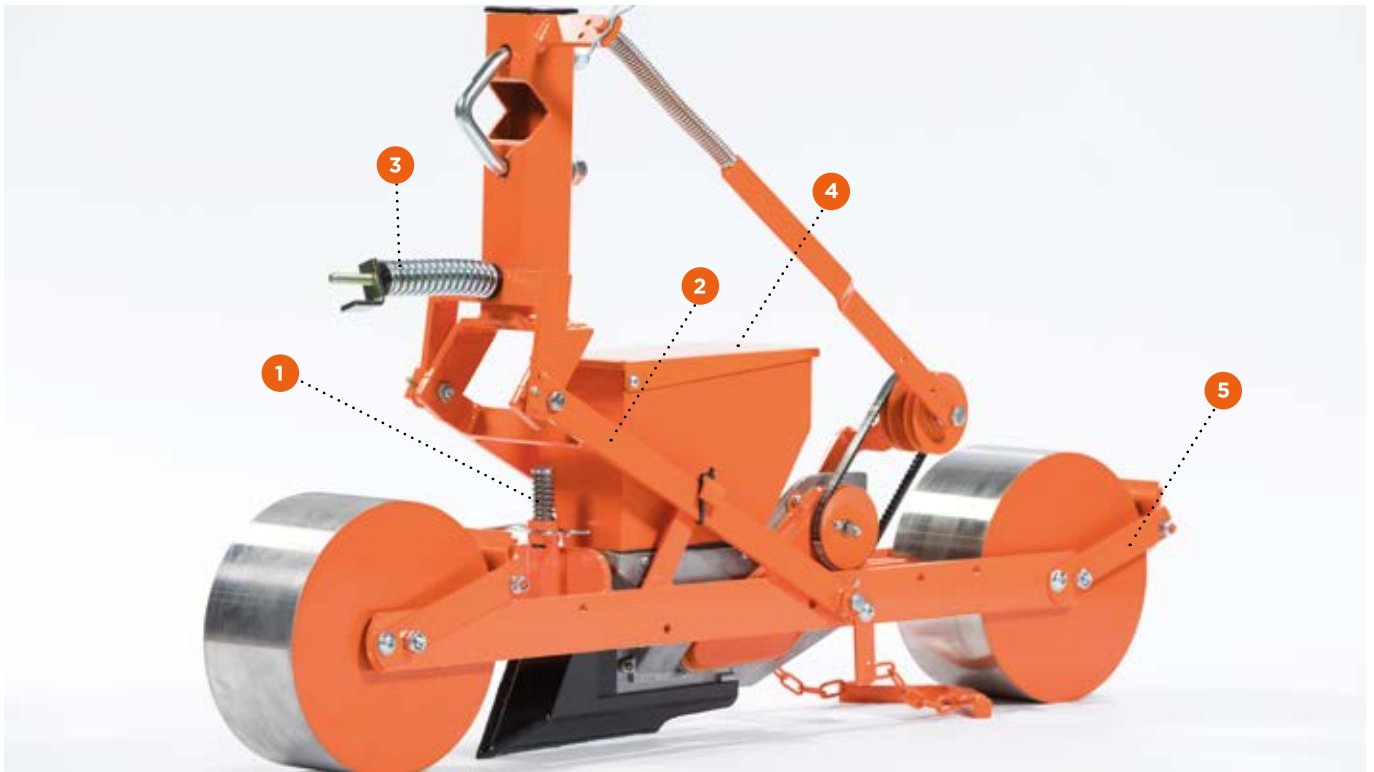

Key Features

- 1 5mm depth adjustment increments via coulter stem between 0-50mm
- 2 Floating linkage
- 3 Adjustable rear wheel pressure via spring
- 4 4 litre seed hopper
- 5 Wheel scrapers
- 6 Adjustable height landwheels

Belt drill options





WHEEL OPTIONS

- 80mm Large Diameter Cage
- 120mm Stainless with Scraper
- 120mm Cage with Scraper



General purpose



Universal Multiline



Non stick ski

COULTERS

General Purpose Single Line

Universal Multi Line

- 50mm 2 Line
- 50mm 3 Line
- 75mm 2 Line
- 75mm 3 Line
- 100mm 2 Line
- 100mm 3 Line

Non Stick Ski Coulters (Plastic)

- 75mm 2 Line
- 75mm 3 Line
- 100mm 2 Line
- 100mm 3 Line

General purpose
Universal multiline
Sticky and/or trashy non-abrasive soils

Air Drills

Stanhay revolutionised the precision planting market when it first developed the air metering unit in the Singulaire 785. Unique in its ability to sow both natural and coated seeds in 1 to 4 lines from each unit while accurately singulating and spacing seeds. With thousands of units sold and over 20 years of proven field performance around the world it continues to provide growers with the most accurate and reliable precision planting performance available.



The metering unit operation relies on a clever airflow system that applies a vacuum behind a thin metal seed disc (A) which flexes to form a perfect seal. As seeds fall from the hopper (B) and past the agitating fingers (C) they get sucked against the holes in the disc. As the disk rotates an adjustable singulator arm (D) ensures only a single seed covers a single hole in the disc. This action is gentle and extremely effective at selecting individual seeds. Once one unit is set, thanks to an easy repeatable setup procedure the settings from this unit can be copied to all others on the drill to produce the same performance. Maintenance of these units is a simple task that requires little specialist knowledge or tools enabling the metering unit to perform like new for many years.

By selecting the correct coulter and seed disc you can plant natural or coated seeds in 1 to 4 lines. One seed disc usually handles all the grades of any seed type, saving you time and expense.

The metering unit can be fitted into a variety of different chassis to suit ground conditions, machine size and row unit spacings.

Single line

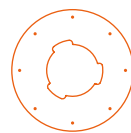

Double line

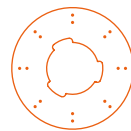

Triple line

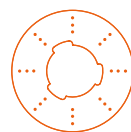

Four line

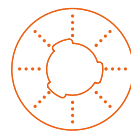



Just some of the seeds you can handle are listed below:

Alfalfa
Anise
Aramanthus
Asparagus
Balm
Basil
Borage
Brassicas
Broccoli
Cabbage
Cantaloupe
Caraway
Carrot
Carthamus
Cauliflower
Celery
Chervil
Chicory
Chives
Chrysanthemum
Coriander
Courgette
Cucumber
Cumin
Delphinium
Dill
Fennel
Fenugreek
Helichrysum
Larkspur
Leek
Lettuce
Marjoram
Melon
Millet
Mustard
Nigella Black Pod
Nigella Oreintalis
Oilseed Rape
Onion
Paprika
Parsley
Parsnip
Peas
Pepper
Pinus Radiata
Poppy
Radish
Red Beet
Rosemary
Sage
Sorghum
Sorrel
Soya
Spinach
Sugarbeet
Swede
Sweet Corn
Sweet William
Thyme
Tomato
Turnip
Watermelon
Wheat



PROAIR

The latest development from Stanhay; 50 years of precision planting experience has gone into designing this row unit. The ProAir is a compact, lightweight but durable row unit packed with adjustability and options to suit any type of ground condition or planting pattern. The drive is maintenance and slip free thanks to a sealed flexible shaft drive system similar to that used on over one million maize drills globally. Coupled with the reliable 26 speed chain driven gearbox and a choice of small or large fans this machine offers the ultimate in precision planting performance.

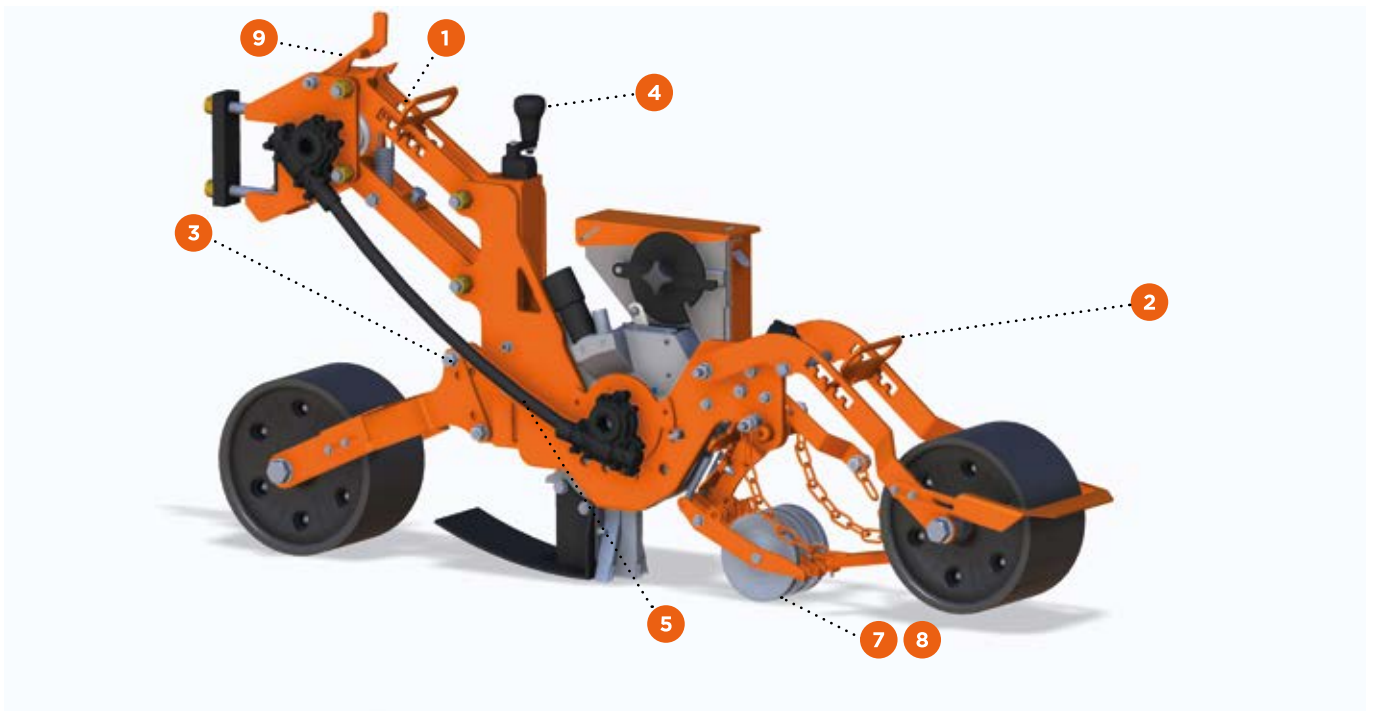

Key Features

- 1 Adjustable row unit down force
- 2 Adjustable rear wheel down force
- 3 Single bolt adjustment to switch between hyline and loline setups
- 4 Infinitely adjustable depth control measurable to a 0.1mm accuracy via a mechanical counter
- 5 Sealed maintenance free flexible drive shaft
- 6 Unobstructed access to the metering unit for maintenance and changing of seed discs
- 7 Independently articulating seed press wheels with adjustable downforce
- 8 Individual scraper blades on each stainless steel press wheel
- 9 Ability to latch row unit out of work



STARPLUS

The StarPlus row unit features premium adjustability features making it easy to adapt to changing field conditions. It features the robust 28 speed chain drive landwheel giving a huge range of spacing with each seed disc and a high performance 26 rib fan. Suitable from 3 - 18+ row machines.



Key Features

- 1 Strong double-sided chassis
- 2 Adjustable unit down force
- 3 Floating parallel linkage for consistent depth control
- 4 Infinitely variable depth control via depth screw

The Star row unit features premium adjustability features making it easy to adapt to changing field conditions. It features the robust 28 speed chain drive landwheel giving a huge range of spacing with each seed disc and a high performance 26 rib fan. Suitable from 3 - 18+ row machines.

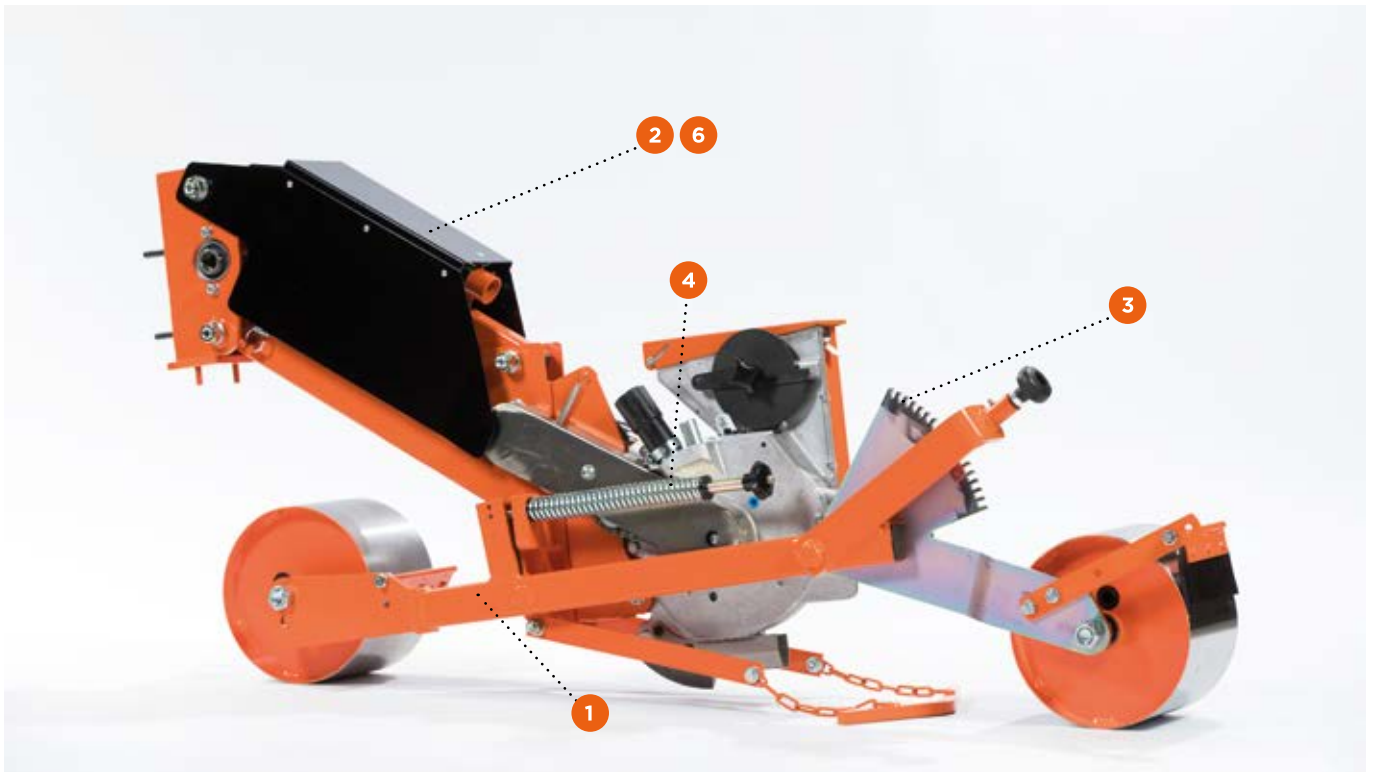

Key Features

- 1 Tough single-sided chassis design
- 2 Floating parallel linkage for consistent depth control
- 3 Easy depth control via rear wheel quadrant in 2.5mm steps
- 4 Adjustable rear wheel pressure via spring
- 5 Unobstructed access to the metering unit
- 6 Adjustable unit down force

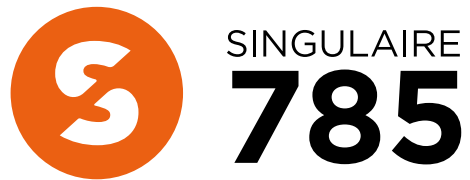
The logo features a stylized orange 'S' inside a circle, followed by the word 'SINGULAIRE' in a smaller font and '785' in a large, bold font.

SINGULAIRE 785

Now superseded by the newer models the 785 was the original Stanhay air drill and is still available today. Based on the chassis design of the 870 it is a dependable drill with thousands of rows still in use around the world.



780

The 780 is the entry level air drill for 2 to 6 rows with a simple single sided chassis design and smaller fan. It is also available in a high density version capable of spacing row units 150mm apart meaning lines can be spaced at just 50mm across the entire planting width. Both units use a 12 speed chain and sprocket landwheel drive system.



Key Features

- 1 Simple but tough single-sided chassis design
- 2 Fingertip depth adjustment
- 3 Unobstructed access to the metering unit
- 4 Floating parallel linkage for consistent depth control



780

HIGH DENSITY

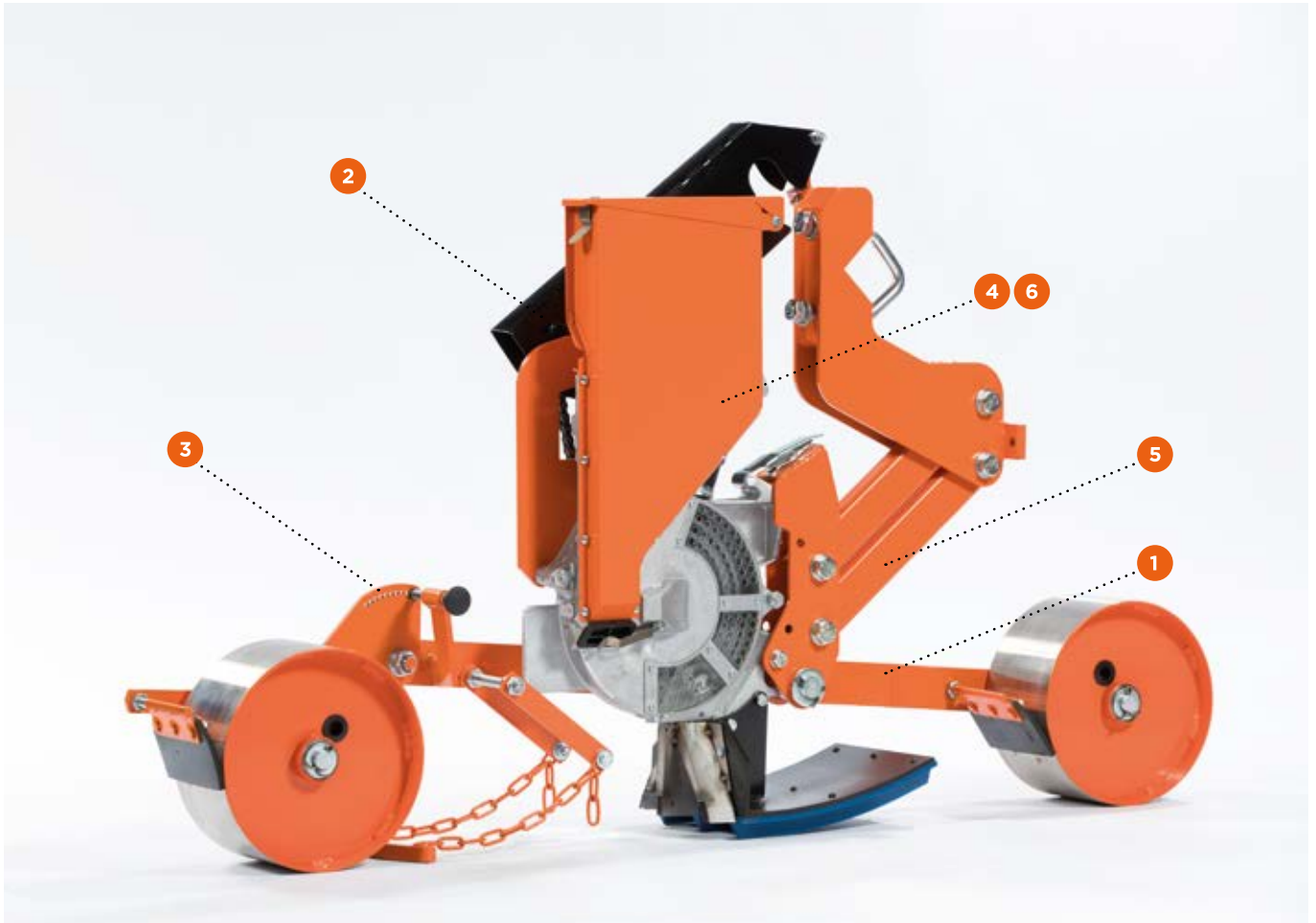

Key Features

- 1 Simple but tough single sided-chassis design
- 2 Narrow drive system
- 3 Fingertip depth adjustment
- 4 Unobstructed access to the metering unit
- 5 Floating parallel linkage for consistent depth control
- 6 Slimline hopper

Air Drill Options



WHEEL OPTIONS

100mm Rubber

Cage with scraper

- o 120mm
- o 160mm
- o 200mm

Stainless with Scraper

- o 120mm
- o 160mm
- o 200mm

100mm Rubber Zero Pressure

100mm Rubber Concave Zero Pressure

140mm (MZP) Zero Pressure

165mm (LZP) Treaded Zero Pressure

OTHER OPTIONS

Seed Press Wheels to suit all different width coulters

Range of double and triple chain drag covers

Single and double sprung arm covers

Hopper Extensions

Clod Deflectors



Clod Deflector



Hyline Ski coulters (Cast or plastic ribs)



Hyline Shallow Fin Coulters



Hyline Deep Fin Coulters



Cast single line

Ceramic single line

COULTER OPTIONS

Ceramic Single Line

Cast Single Line

Loline Ski (Cast or Plastic Ribs)

- o Single Line
- o 75mm 2 Line
- o 75mm 3 Line

Hyline Ski (Cast or Plastic Ribs)

- o Single Line
- o 65mm 2 Line
- o 65mm 3 Line
- o 75mm 2 Line
- o 75mm 3 Line
- o 100mm 2 Line
- o 100mm 3 Line
- o 100mm 4 Line
- o 125mm 2 Line
- o 125mm 3 Line
- o 150mm 2 Line
- o 150mm 3 Line
- o 150mm 4 Line

Loline Shallow Fin

- o 65mm 2 Line
- o 65mm 3 Line
- o 75mm 2 Line
- o 75mm 3 Line

Hyline Shallow Fin

- o 65mm 2 Line
- o 65mm 3 Line
- o 75mm 2 Line
- o 75mm 3 Line
- o 100mm 3 Line

Hyline Deep Fin

- o 75mm 2 Line
- o 75mm 3 Line
- o 100mm 2 Line
- o 100mm 3 Line
- o 125mm 2 Line
- o 125mm 3 Line
- o 150mm 3 Line

Extra hard wearing for sticky or abrasive soils

General purpose single line work

Sticky and/or trashy
non-abrasive soils

Sticky and/or trashy
non-abrasive soils

Fine cloddy
or stoney seedbeds

Fine cloddy or stoney seedbeds.
Shallow fins can handle stones
or clods without blocking

Fine seed beds, deep fin shoes
produce minimum soil disturbance

Cell Wheel Drills

With regular shaped or pelleted seed, the Stanhay cell wheel metering unit is unmatched and with the correct setup offers near perfect single line performance. With few moving parts running costs are low and maintenance simple. Originally developed for pelleted Sugar Beet in the UK the system is just as effective with a range of other pelleted seeds such as lettuce.



Seed falls from the hopper into a selection chamber which is positioned vertically above the cell wheel, here the seeds fill the individual cells while the cell wheel and deflector wheels rotate anticlockwise. The deflector wheel gently rolls excess seed away from the wheel to ensure only one seed per cell. The seed ejection point is at the bottom of the unit close to the ground where a special ejector plate ensures precise consistent ejection of seed to maintain accurate seed spacing.



The metering unit is available in one chassis with two different drive options, mechanical and electric drive.



SEVEN

The successor to the Webb drills, the Seven is a dependable, robust and simple machine to operate. A 28 speed chain and sprocket drive landwheel shared with the Star and ProAir machines provides the positive drive. The single sided chassis is the same as used on the Star machine with easy depth adjustment.



Key Features

- 1 Tough single sided chassis design
- 2 Floating parallel linkage for consistent depth control
- 3 Easy depth control via rear wheel quadrant in 2.5mm steps
- 4 Adjustable rear wheel pressure via spring
- 5 Single sided mechanical drive
- 6 12 litre seed hopper



With no chains, sprockets or gearboxes and a host of further functionality not possible with conventional landwheel driven drills, the Nine is a high precision and low maintenance drill where each unit is driven by its own electric motor. This allows infinitely adjustable seed spacing directly from the tractor seat as well as the benefits of section control, guidance and variable rate seeding when paired with the correct ISOBUS terminals.



Key Features

- 1 Tough single sided chassis design
- 2 Floating parallel linkage for consistent depth control
- 3 Easy depth control via rear wheel quadrant in 2.5mm steps
- 4 Adjustable rear wheel pressure via spring
- 5 Slim line Individual Electric Motor Drive
- 6 12 litre seed hopper
- 7 ISOBUS compliant

The Nine is in the final stages of development and testing, due for release during 2018.

Cell Wheel Drill Options



WHEEL OPTIONS

100mm Rubber

Cage with scraper

- 120mm
- 160mm
- 200mm

Stainless with Scraper

- 120mm
- 160mm
- 200mm

100mm Rubber Zero Pressure

100mm Rubber Concave Zero Pressure

140mm (MZP) Zero Pressure

165mm (LZP) Treaded Zero Pressure



Cast Single Line



Ceramic single line

COULTERS

Ceramic Single Line

Cast Single Line

OTHER OPTIONS

Sprung loaded seed press wheel

Clod Deflectors



Seed press wheel

Frame options and extras

Stanhay machines come with a range of toolbar options and extras to suit the drill size, layout and working conditions.

TOOLBARS

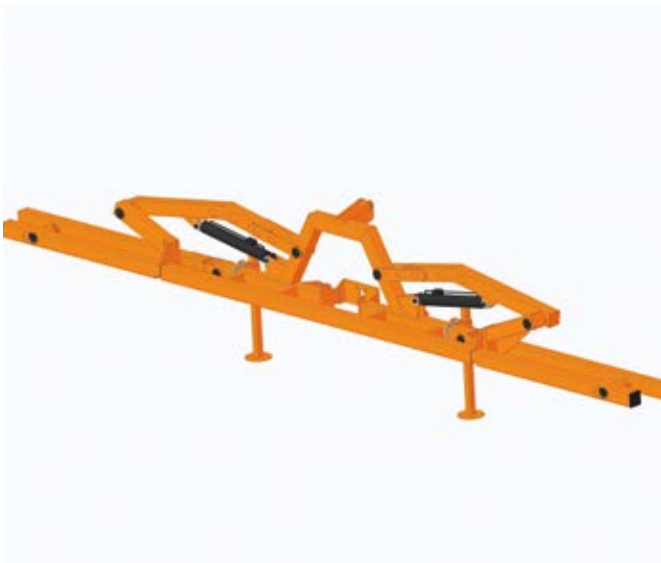

Key Features

- 1 Rigid toolbars up to 6.5m in width for 60 diamond, 100 and 180 square toolbars.
- 2 6m horizontal stacking frame which folds to 3m for road transport.

FANS



Key Features

- 1 17 Rib and 26 Rib fans are available with PTO drive in either 540RPM or 1000RPM configurations.
- 2 Hydraulic motor drive systems can be specified at point of order for all fans and can also be retrofitted. These are designed to require low oil flow rates around 10-20LPM to allow the tractor to be run at low speed.
- 3 A vacuum emptier can be fitted to all air drills to enable easy clear out of hoppers at the end of work or when switching between varieties.

MARKER ARMS

Key Features

- 1 Range of both manual and hydraulic marker arms to accurately mark bouts during field work.

LAND WHEELS



Key Features

- 1 Drive shaft extensions to power secondary equipment such as fertiliser applicators are available.
- 2 Landwheels can also be sprung loaded to ensure positive drive on the outside wheels of larger machines or where ground conditions make it necessary.

MONITORS



Key Features

- 1 Basic rotation monitors can be specified for all types of machines which display a warning in the cab if a unit is not rotating, ensuring the problem can be resolved quickly without loss of yield.
- 2 Simple and economical area monitors allow the grower to get an accurate measure of the amount of land that has been worked.

GRANULAR FERTILISER APPLICATORS



Key Features

- 1 These can be fitted on request to apply a granular fertiliser at the same time as planting. They can be driven from the land wheel of the drill or via electric motors.

Bespoke machines

Stanhay has the capability of designing and producing specialist seed drilling machines for specific requirements and applications on request.

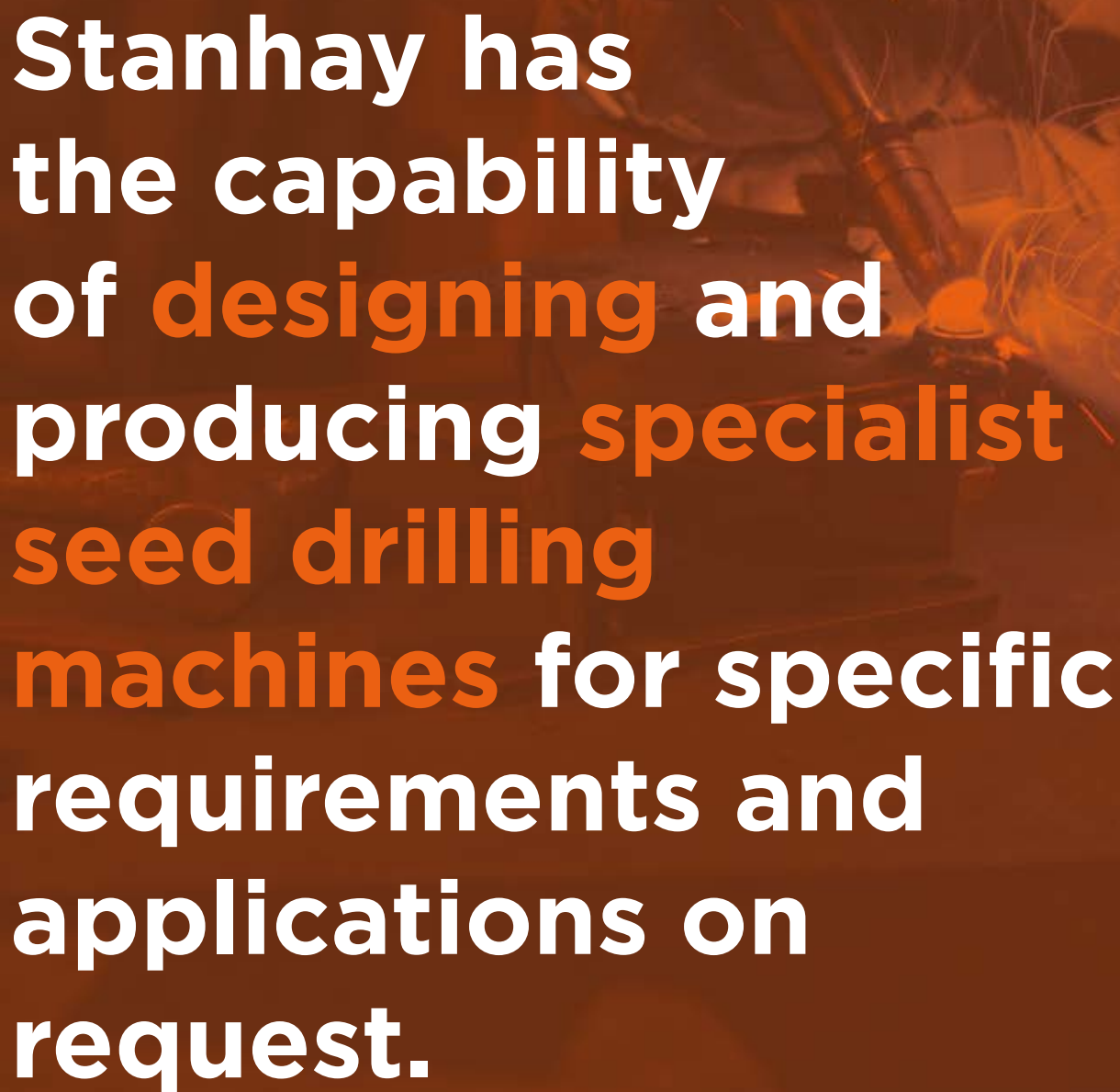

Stanhay has the capability of designing and producing specialist seed drilling machines for specific requirements and applications on request. These can range from multi-bed high density machines, to sled mounted or tandem bed drills for almost any type of seed. If you would like a bespoke machine designed for your specific requirements then please get in contact with your nearest Stanhay dealer.

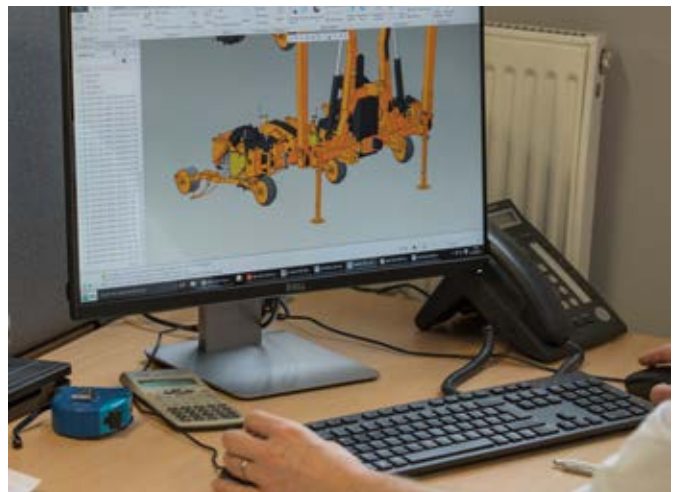

Dealer Locations



AUSTRALIA

Farmgard
15 Paraweena Drive
Truganina
Victoria 3029
☎ 0061800327642
www.famgard.com.au

NEW ZEALAND

Farmgard
21 Andrew Baxter Drive
Mangere Manukau
Auckland 2022
☎ 006492755555
www.famgard.co.nz

NZ Tractors

Spring Farm
Winslow No5 Road
Asburton 7775
☎ 006492755555
www.nzt.nz

USA

Solex Corporation
220 South Jefferson Street
Dixon
California 95620
☎ 0017076785533
www.solexcorp.com

CANADA

R+W Equipment
5221
11th Line
Cookstown
Ontario. LOL 1LO
☎ 0017054584003
www.rwequipment.ca

BRAZIL

STA Maquinas
BR-153, Lt 18/19
Chacaras Retiro
74.620-425
☎ 00556236363050
www.stamaquinas.com.br

GERMANY & POLAND

Ruthenberg Landtechnik
Carl-Borgward-Str.1
D-33335
Gütersloh
☎ 004952419957720
www.ruthenberg-landtech-
nik.de

RUSSIA

JSC Yug Agromashimport
Stavropolsky Krai
Stepnaya Street
2 Ipatova 356630
☎ 0078654257706
www.jugagromashimport.
com

PORTUGAL

Gêbêcê Moto Agro
Quinta da Centieira
Povoa da Isenta
2005-085 Santarém
☎ 00351243760712
www.gebece.pt

GREECE

G.I. Antonakis S.A.
3ES KM Thiva-Mouriki
32200 Thiva
☎ 003022620258915
www.antonakis-agro.gr

AUSTRIA

Agrotech
A-2230
Gänserndorf Protteser
Strasse 38
☎ 004322824376

ESTONIA

AS Schetelig EV
Ehitajate tee 148 A
13517 Tallinn
☎ 003726512950

CZECH REPUBLIC

Holik Agroservis
Karafatova 17
77900 Olomouc
☎ 004200685412408

We have dealers worldwide ready to supply you with the right product.



SOUTH AFRICA

Morning Dew Farms
PO Box 86025
City Deep 2049
Gauteng
☎ 0027116134267
www.mdf.co.za

DENMARK

**Haarby Smedie
& Kuntsmedie Aps**
Staermosevej 3
DK-5683 Haarby
☎ 004564732150
www.haarbysmedie.dk

ZAMBIA

Sonseth Enterprises
12 Njoka Road
Olympia
Lusaka
☎ 0026978450132

SPAIN

Niño
Avda. Camilo Jose
Cela 49 40200 Cuellar
☎ 0034921140585
www.maquinaria-nino.com

ISRAEL

Yaadim Marketing
P O Box 304
Industrial area
Ashkelon 78102
☎ 0097286751181

SWEDEN

R J Maskiner AB
Bryggerigatan 11
S-267 39 Bjuv
☎ 00464281555
www.rjmaskiner.se

FINLAND

Scanline OY
Hameentie 1 LH 1
132000 Hameenlinna
☎ 00358405639496

UKRAINE

Unifer LLC
Melitopolska. 17B 74800
Kakhovka
Kherson Region
☎ 00380553627131
www.unifer.com.ua

NETHERLANDS

Ganlok Agro Trade BV
Willemskade 28A
NL8911 BB
Leeuwarden
☎ 0031321381900

CHINA

Stanhay Webb China
1/F, Charles L Corn Building
26 Wing Lok Street
Sheung Wan
Hong Kong
☎ 00852 23896319
www.stanhay.cn

INDIA

National Agro Industries
Link Road
Industrial Area-A, OPP. Trans-
port Nagar
Ludhiana, Punjab
☎ 00918146101101
www.nationalagro.com

FRANCE

Simma
828, Route d'Aix en Provence
BP 50
84122
Pertuis Cedex
☎ 0033466332190
www.simma.fr

UK + IRELAND

Stanhay Webb Ltd
BCS House
Pinfold Road
Bourne
PE10 9HT
☎ 00448451801480
www.stanhay.com

Contact us



WRITE TO US AT:

STANHAY WEBB LTD
BSE HOUSE
PINFOLD ROAD
BOURNE
PE10 9HT



EMAIL US AT:

INFO@STANHAY.COM



CALL US AT:

+44 (0)1778 392 303



VISIT US AT:

WWW.STANHAY.COM



TWITTER:

[@STANHAYWEBB](https://twitter.com/STANHAYWEBB)

NOVEMBER 2017



**Because
sometimes
precision is
everything.**

Place dealer address here:



STANHAY

WWW.STANHAY.COM